



Interactive Intelligent Panel

Owner's Operating Manual



Before operating the unit, please read this manual thoroughly and retain it for future reference.

All the pictures in this manual are for reference only, please refer to the actual product when there are differences.

Safety Warning

Before operating the unit, please read this manual thoroughly, and keep it for future reference.

Placement

Do not place the unit on an unstable cart, stand, tripod, bracket, table, or shelf.
Do not expose the unit to direct sunlight and other sources of heat.
Do not put the unit near appliances that create magnetic fields.
Do not put any liquid near or on the unit, make sure do not spill any liquid inside the unit.
Do not put heavy objects on top of the unit.

Power Supply

Check that the unit's operating voltage is identical with your local power supply.
Please unplug power supply and antenna plug when the weather is thunder-storm or lightning.
Please unplug power supply, when there is nobody home or the unit will be in idle for a long time.
Please keep power cable from physical or mechanical damage.
Please use the original power cable from the accessory bag, don't modify or lengthen it.
Please check and ensure AC source is connected with the ground.
This device comes standard with a power cable exclusively for this device only.

LED Screen

Never use any other tough or sharp object to replace the touch pen.
Unplug the power cable before cleaning.
Clean the screen with a soft dustless and dry cloth.
Never use water or the spray type detergent to clean the unit.
For deep clean, please contact an authorized service center.
Better for the panel lifetime and the display performance, do not display high brightness image for long time.

Sight Distance

The best distance between audience and screen is 5-7 times that of screen diagonal.
The best watching angle between audience and screen is within 176 degree from difference directions.

Temperature

Do not place the unit near or over a radiator or a heater.
If your unit is suddenly moved from a cold to a warm place, please unplug the power cable and do not turn it on at least 2 hours, making sure the moisture inside the unit is all evaporated.
Normal operating temperature is 0 ~ 40°C.

Humidity

Do not expose machine in rain, or place with high humidity.
Please make sure indoor environment is dry and cool. Normal operating humidity is 10~90%.

Ventilation

Please put the unit in a well ventilated place, so the heating can be released easily.
Ensure that the unit has enough space for ventilation around: left, right and back >10cm, top > 20cm.

Earphone

Using the earphone to listen loud sound for a long time might effect the hearing.
Before using earphone, please turn down the volume in advance.

Standby

It will enter standby mode but not turn off the unit while press the standby key.

Battery

Please make sure the battery get proper disposal or recycle after using.
Please keep the battery away from kids and don't throw the battery into fire.

Notes for Cleaning

There are vents on back cover, please do not use any liquid or spray directly during cleaning.

Power Switch Status Signs

"I" means power on, "O" means power off.

Notes for Maintenance

This machine can only be maintained by certified engineer.





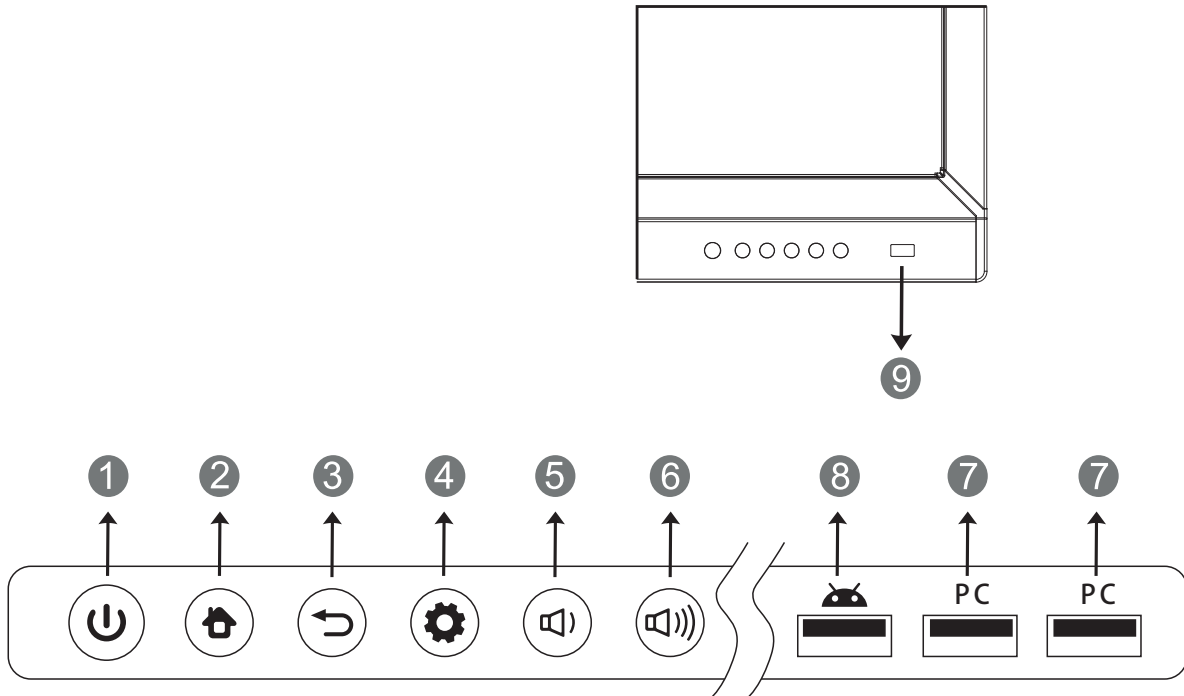

Contents

Security Warning	1
Prepare to Install	2
Connection and Setting	7
Menu Operation	11
Simple troubleshooting	15
Maintenance	16

Prepare to Install

1 Control Panel



Items	Function description
① 	Tap to enter EnergySaving function Press at least 2 seconds to enter standby mode
② 	HOME button: back to main interface
③ 	Return button: return to previous level menu
④ 	Menu button: call up function menu
⑤ 	Volume down button: turn down volume
⑥ 	Volume up button: turn up volume
⑦ PC	Built-in computer USB interface
⑧ 	USB interface of Android system, which can access storage device to play media files
⑨ Remote control signal receiver	Receiving remote control signal, and do not place any objects to block remote control receiving

2 Terminal interface

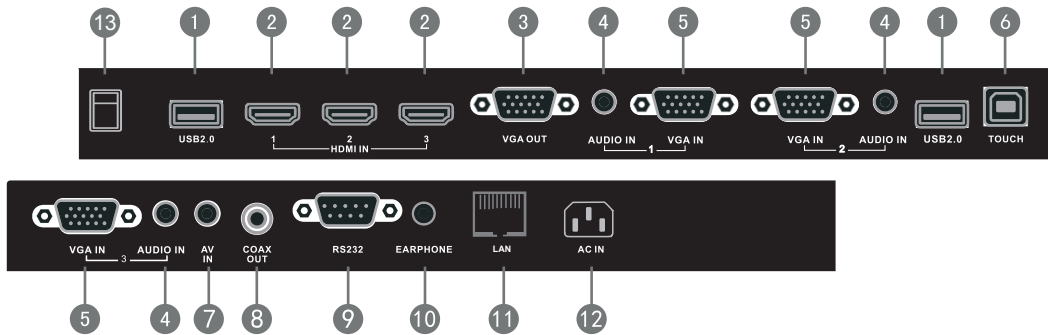







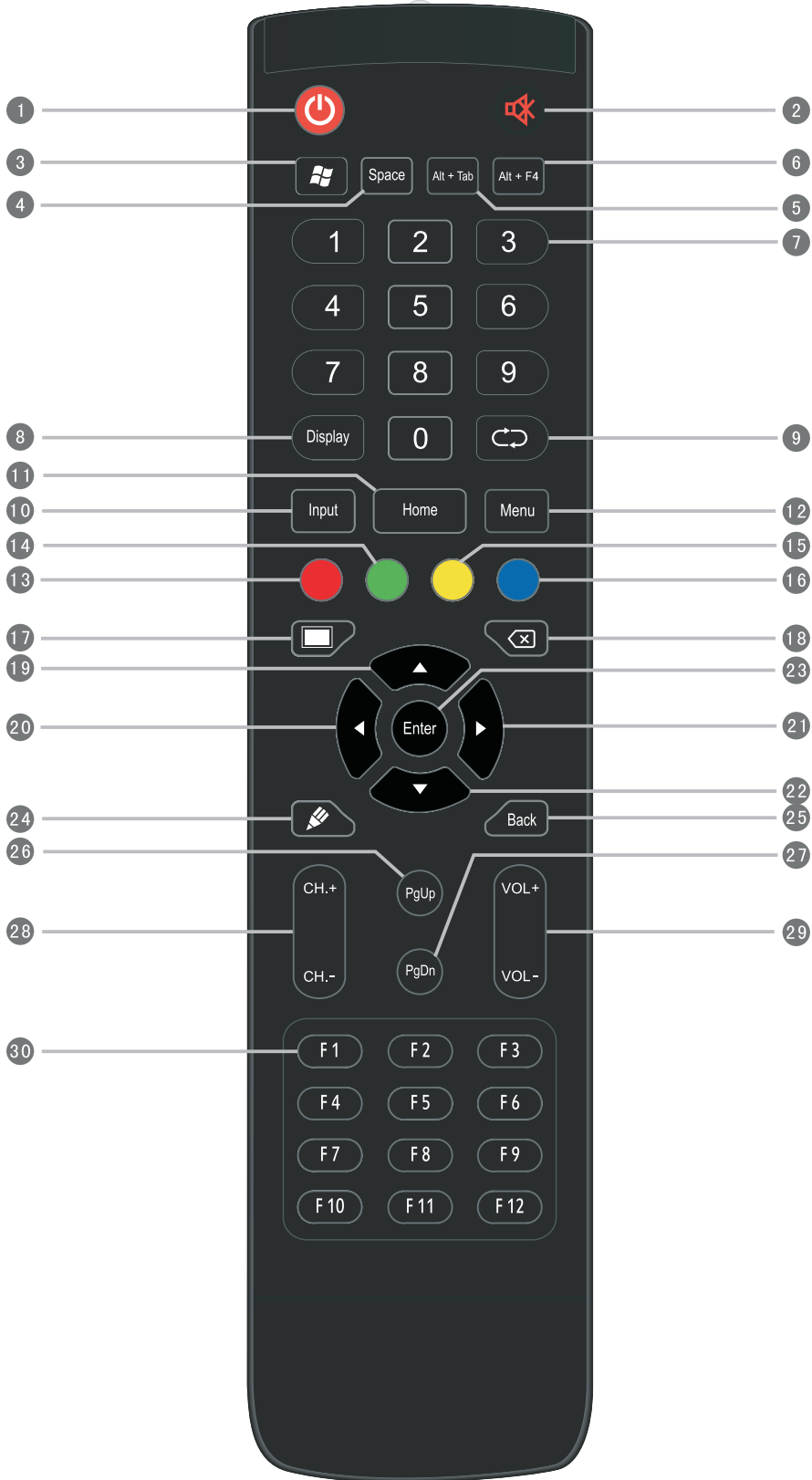



Items	Function description
① USB	Connect USB devices such as mobile hard disk, U disk, USB keyboard and mouse, USB drives, etc
② HDMI IN	High-definition multimedia interface signal input, connect to PC (personal computer) with HDMI output, set-top box, or other video device can also realize touch function
③ VGA OUT	Connected to display devices with VGA input function
④ AUDIO IN	External computer audio input
⑤ VGA IN	External computer image input
⑥ TOUCH	External computer touch signal input. Default touch function is available under internal computer, when connecting external computer, besides connecting external computer VGA and audio signals, external computer's USB port needs to be connected to the equipment. Under the condition that driver is installed, external computer can be touch controlled through the equipment (touch function is effective in PC, VGA and HDMI channel by default)
⑦ AV IN	Composite video and audio input
⑧ COAX OUT	Coaxial output
⑨ RS232	Serial interface, used for mutual transfer of data between devices
⑩ EARPHONE	Connected to device with headphone input function
⑪ LAN	LAN interface, connecting RJ45 terminals. (This network port is only used for Android system)
⑫ AC IN	AC power input, connecting AC power supply
⑬ POWER SWITCH	Power switch, to open and shut down AC power supply “1” means power on, “0” means power off.

3 Remote control

1) Remote control button instruction



Detailed function description of remote control buttons

- 1  : Power on/off
- 2  : Mute switch
- 3  : Built-in computer Windows key
- 4 Space : Built-in computer Space key
- 5 Alt+Tab : Built-in computer spacebar Alt + Tab
- 6 Alt+F4 : Built-in computer program window close button
- 7 Numeric keys : TV digital channels input keys
- 8 Display: Display channel information
- 9  : TV channel return key
- 10 Input: Input signal source selection key, choose different sourced according to need
- 11 Home: Android system main screen button
- 12 Menu: TV OSD menu button, press this button to pop up TV's OSD menu
- 13 Red: Function button
- 14 Green: Function button
- 15 Yellow: Function button
- 16 Blue: Function button
- 17  : One key for blank screen
- 18  : Backspace key
- 19  : Direction key, press this button for upwards selection
- 20  : Direction key, press this button for left selection
- 21  : Direction key, press this button for right selection
- 22  : Direction key, press this button for downwards selection
- 23 Enter: Confirmation key, press this key to confirm selection state
- 24  : Quickly start writing software, select writing pen quickly if software is started.
- 25 Back: Return key
- 26 PgUp: Built-in computer page (previous page)
- 27 PgDn: Built-in computer page (next page)
- 28 CH.+ \ CH-: Function button
- 29 VOL+ \ VOL-: Volume switch key
- 30 F1-F12: Built-in computer F1 - F12 function keys

NOTE: In case of no built-in computer, all function keys related with computer are regarded as no operating functions

2) Remote control instruction

Install Batteries

- 1 Open back cover of battery component on the back of remote control
- 2 Install AAA type battery according to the corresponding electrode, make sure battery positive and negative pole are correct ("+" to "+", "-" to "-"), please do not mix using old and new batteries
- 3 After battery is installed, close the back cover of battery components, and make the following clip buckled to the bottom

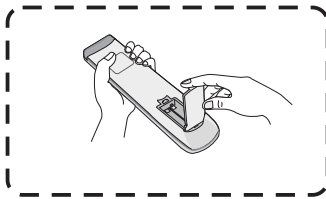

(1)

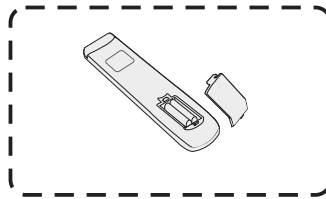

(2)

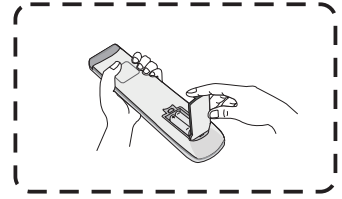

(3)

Range of remote control

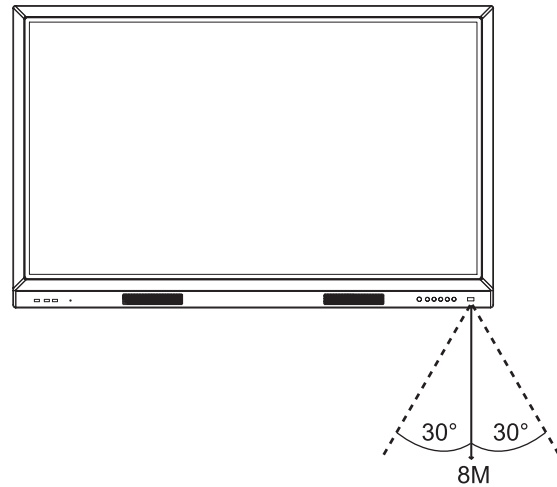

Remote control can work normally within the range of 8 meters distance, 30 degrees left and right from the remote control receiver; in order to protect environment, please dispose waste battery into recycling box.

CAUTION
 RISK OF EXPLOSION IF BATTERY IS REPLACED
 BY AN INCORRECT TYPE
 DISPOSE OF USED BATTERIES ACCORDING
 TO THE INSTRUCTIONS

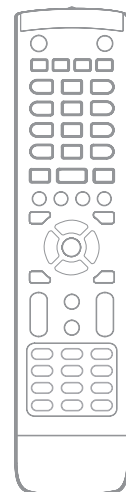

Connection and Setting

 For the safety of you and the machine, please do not connect any power plug before connection

1. External Computer and Touch Connection

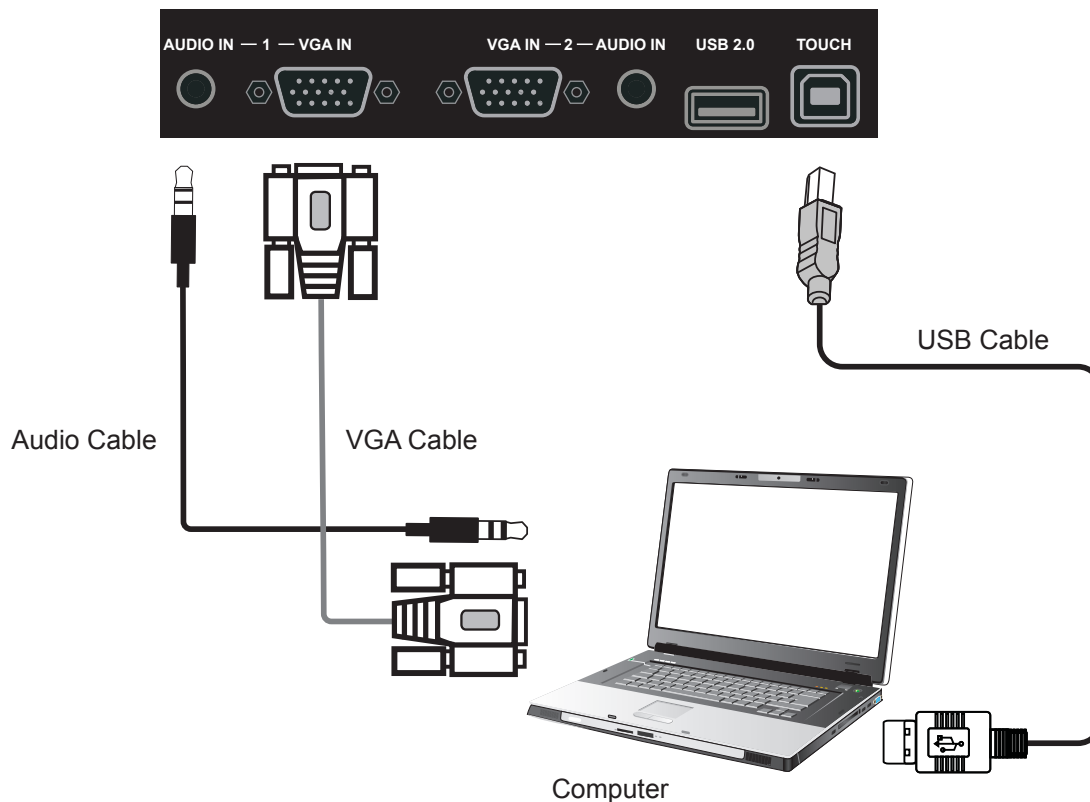

- (1) Use VGA line to connect to VGA output port of external computer, and meanwhile use headphone audio line to connect to external computer audio output interface
- (2) Use USB line to connect to external computer USB port
- (3) After line connection, plug in power cord, and switch power on
- (4) Start external computer
- (5) Press  key, and the equipment is power on
- (6) Press the INPUT key to switch to VGA channel



NOTE:

External computer input, equipment's best resolution is 1920 x1080

External computer can also connect to the equipment through the HDMI cable

• Recommended computer configuration:

2.0GBHZ Processor, 1GB Memory

More than 256 color display card

1GB Available Hard Drive

Support Resolution 800*600,1024*768,1920*1080

VGA-OUT/HDMI-OUT、Audio-OUT、USB Interface

2. Audio and video equipment

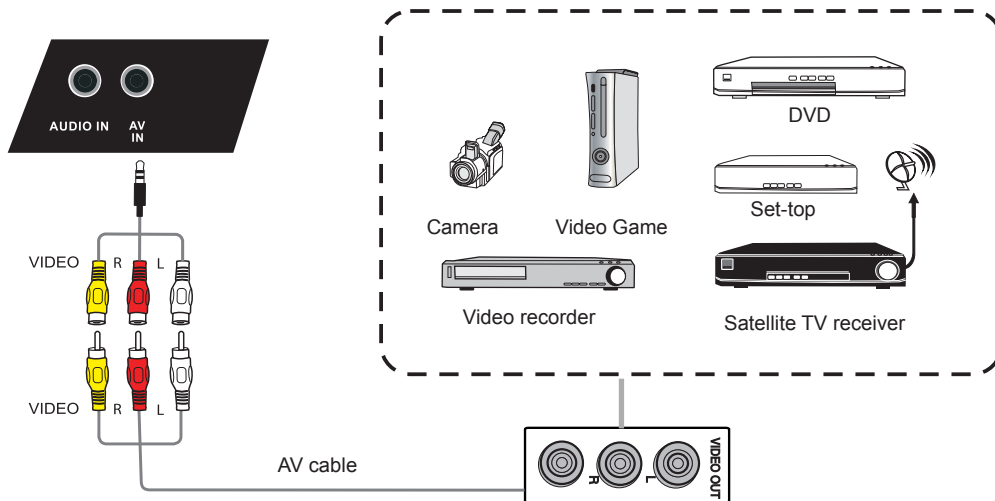

- (1) Use AV audio and video lines to connect audio and video equipments with AV output (yellow for video, red for right sound channel, and white for left sound channel)
- (2) After line connection, plug in power cord, and switch power on
- (3) Press  to turn equipment on
- (4) Press INPUT key to switch to AV port

2) HDMI1/HDMI2/HDMI3

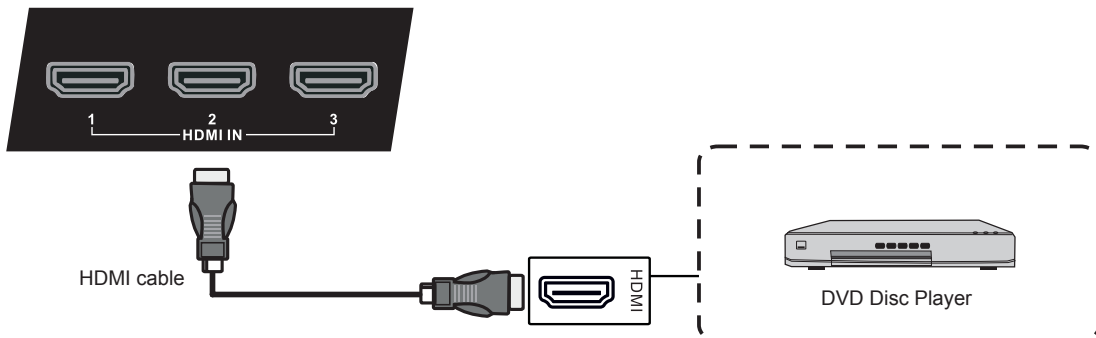

- (1) Use HDMI line to connect audio and video equipment with HDMI output
- (2) After line connection, plug in power cord, and switch power on
- (3) Press  to turn equipment on
- (4) Press INPUT key to switch to HDMI port

3. Coaxial connection

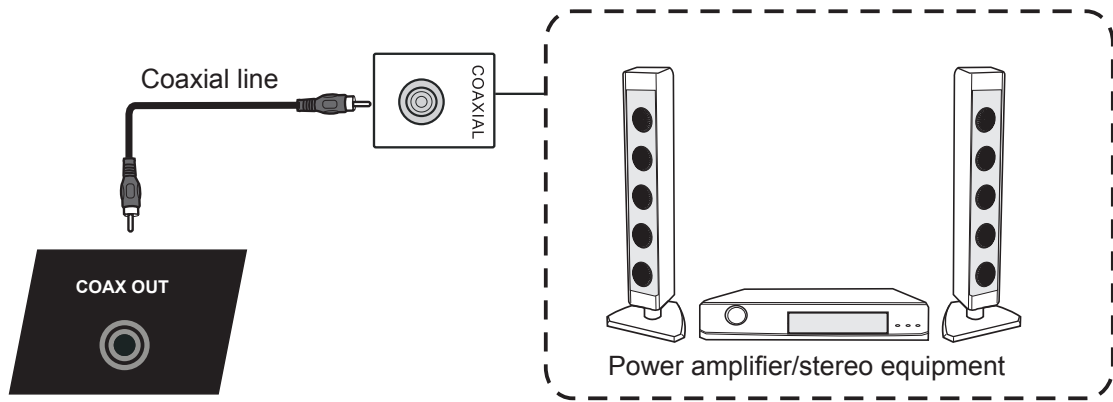

- (1) Use coaxial line to connect audio device with coaxial input
- (2) After line connection, plug in power cord, and switch power on
- (3) Press  to turn equipment on

4. Video output connection

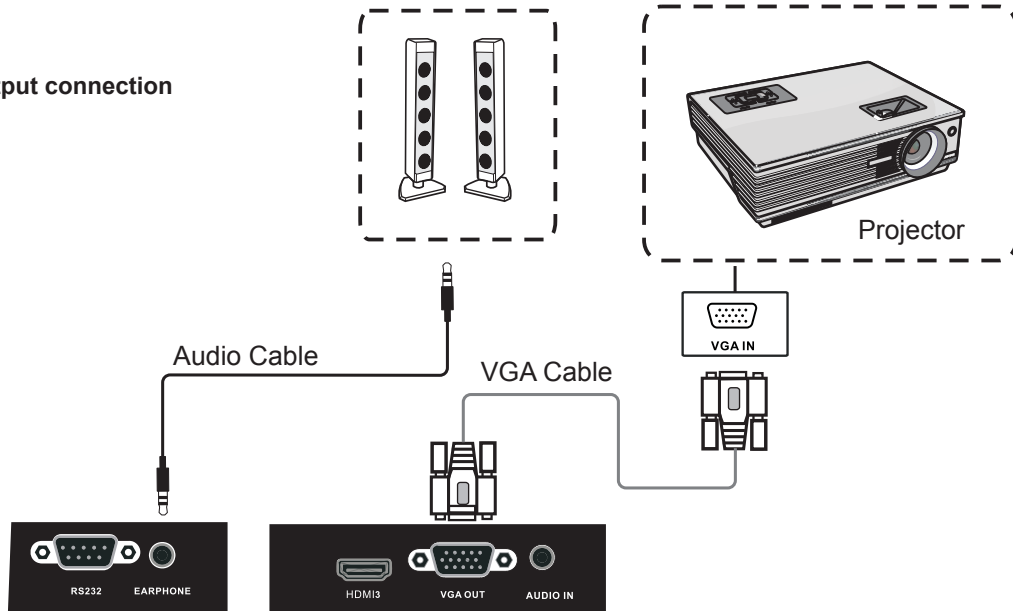

- (1) Use VGA line to connect display devices with VGA Out, and use headphone line to connect sound output
- (2) After line connection, plug in power cord, and switch power on
- (3) Press  to turn equipment on
- (4) Press INPUT key to switch to VGA port

Note: VGA OUT & EARPHONE outputs VGA IN & AUDIO IN graphics and sound.

5. LAN Connection

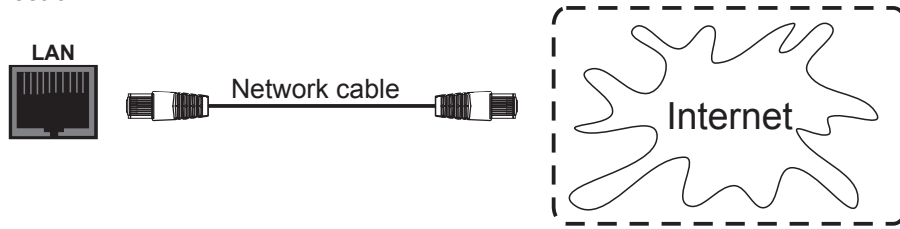

6. RS232 connection

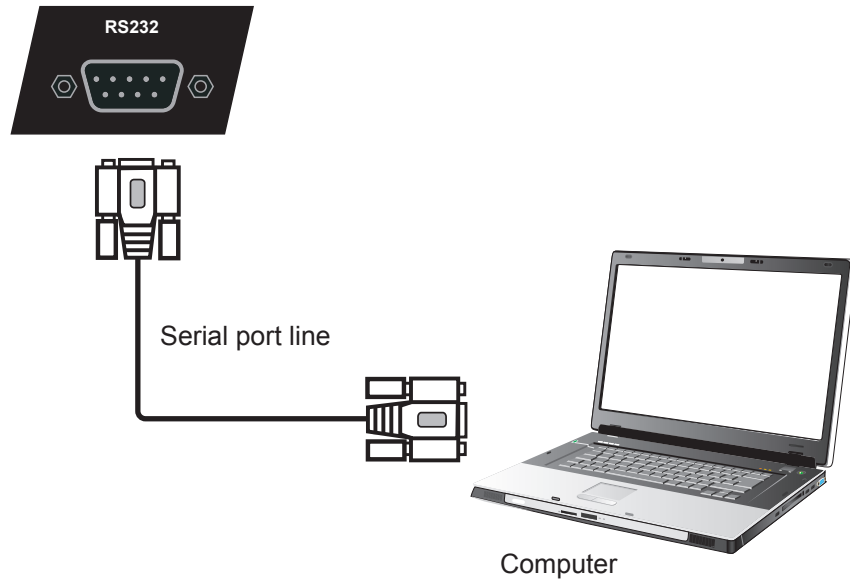

After using serial port line to connect central control equipment and machine, certain function of the machine can be controlled via central control equipment, such as: machine ON/OFF, and adjustment of sound volume, etc.

Menu Operation

Touch menu operation

Call up method

Take middle point position on the bottom of display screen as starting point, use touch pen to drag towards screen center position to call up touch menu, as shown below.

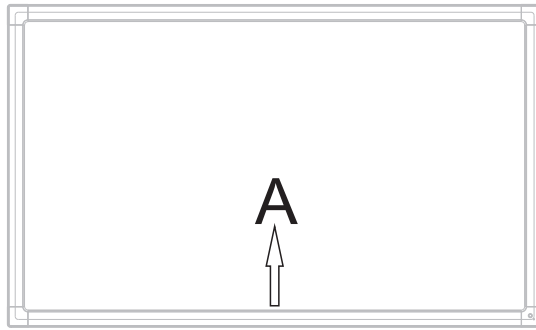

Note: "Touch A Method" mentioned in this manual to call up touch menu method is shown above.

Setting menu

Input setting



- Press INPUT button on remote control or via touch A method to call up Input Setting menu;
- Press ▼/▲/◀/▶ button on remote control to select the channel you need;
- Press the Enter button on remote control or directly click with touch pen to confirm selected input channel;
- Press return key on remote control, or click blank area outside menu with touch pen to exit menu.

Note: PC channel will only display when you connect the built-in computer.

Brightness setting

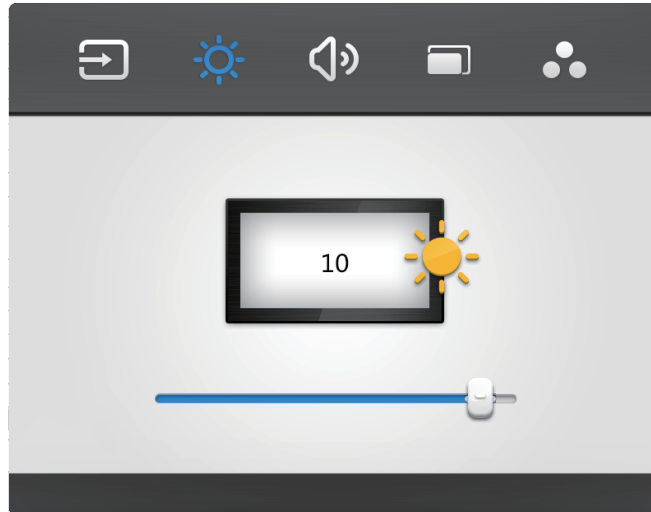

- Press INPUT button on remote control or via touch A method to call up Input Setting menu;
- Press ► button on remote control or directly click “☀️” icon with touch pen to enter Brightness Setting menu;
- Press ▼, ◀️/▶️ button on remote control or drag brightness adjustment progress bar with touch pen to adjust brightness;
- Press return key on remote control, or click blank area outside menu with touch pen to exit menu.

Volume setting

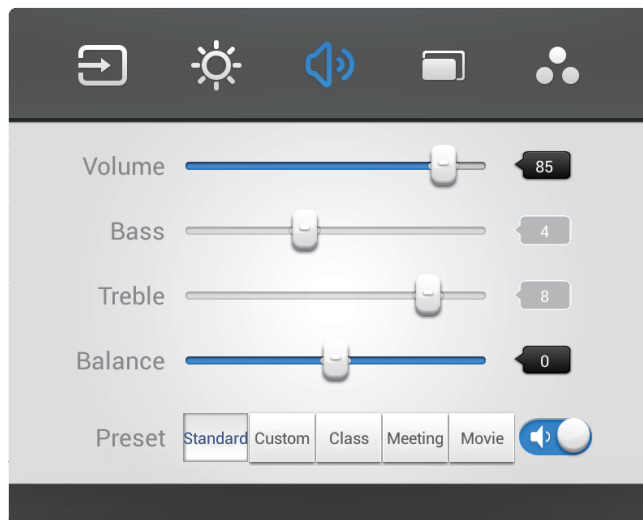

- Press INPUT button on remote control or via touch A method to call up Input Setting menu;
- Press ► button on remote control or directly click “🔊” icon with touch pen to enter Volume Setting menu;
- Press ▼, ◀️/▶️ button on remote control or directly drag volume adjustment progress bar with touch pen to adjust volume;
- Press <🔇/> button on remote control or directly click mute icon below “☰” with touching pen to open or close mute state;
- Press return key on remote control, or click blank area outside menu with touch pen to exit menu.

Zoom setting

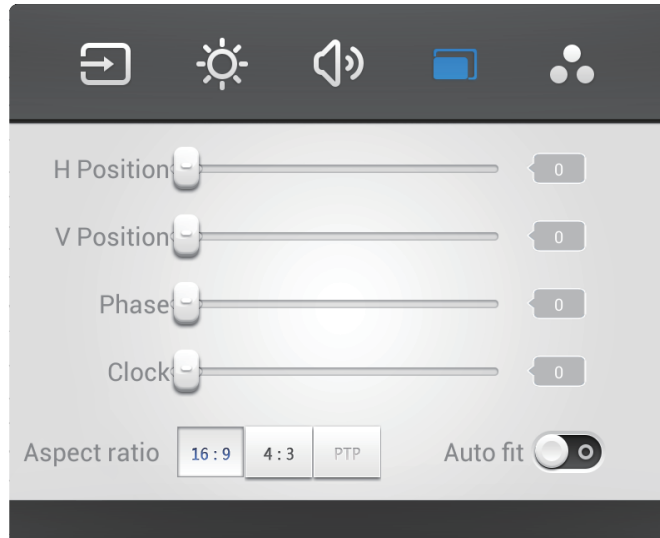

- Press INPUT button on remote control or via touch A method to call up setting menu;
- Press ► button on remote control under setting menu or directly click “” icon with touch pen to enter setting menu;
- Press ▼/▲/◀/▶ button on remote control or click directly with touch pen to select and adjust each option;
- Press return key on remote control, or click blank area outside menu with touch pen to exit menu.

H position

Press ◀/▶ button on remote control or directly drag icon with touch pen to adjust horizontal position of image;

V Position

Press ◀/▶ button on remote control or directly drag icon with touch pen to adjust vertical position of image;

Phase

Press ◀/▶ button on remote control or directly drag icon with touch pen to adjust phase position of image;

Clock

Press ◀/▶ button on remote control or directly drag icon with touch pen to adjust clock of image;

Aspect ratio

Press ◀/▶ button on remote control or press Enter button or directly click icon with touch pen to switch image display ratio;

Auto fit

Press Enter button on remote control or directly click icon with touch pen to automatically adjust horizontal, vertical position/ phase and clock of image.

Screen setting

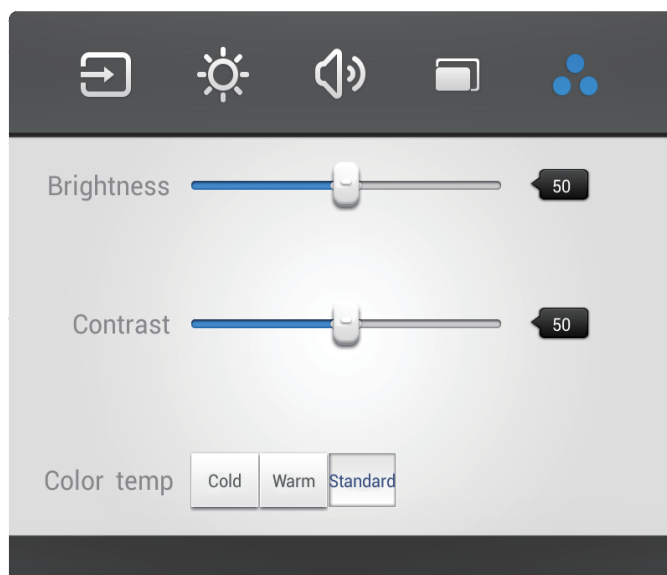

- Under channels other than Android, press Menu button on remote control or via touch A method to call up setting menu;
- Press ► button on remote control or directly click "☰" icon with touch pen or directly press Menu on remote control to enter advanced setting menu;
- Press ▼/▲/◀/▶ button on remote control or click directly with touch pen to select and adjust each option;
- Press return key on remote control, or click blank area outside menu with touch pen to exit menu.

Brightness

Press ◀/▶ button on remote control or directly drag icon with touch pen to adjust brightness of image.

Contrast

Press ◀/▶ button on remote control or directly drag icon with touch pen to adjust contrast of image.

Color temp

Press ◀/▶ button on remote control or directly drag icon with touch pen to adjust color temperature of image(Cool color/warm color/auto matic).

Note: Different options in different channels can't be adjusted, please select according to actual situation.

Simple troubleshooting

Machine fails to work normally

Remote control failure	<ol style="list-style-type: none"> 1. Check whether there are other objects between remote control and television remote control receiving window, thus leading to failure of remote control. 2. Check whether the battery electrode in the remote control is correct. 3. Check whether remote control needs to replace battery.
Machine automatically shut down	<ol style="list-style-type: none"> 1. Whether set sleep or not. 2. Check whether there is sudden power outage. 3. Check whether there is no signal automatic shutdown.

PC mode

Signal out of range	<ol style="list-style-type: none"> 1. Check whether display is set correctly. 2. Check whether resolution is the best resolution. 3. Adjust line and field synchronization in menu.
Background has vertical lines or streaks	<ol style="list-style-type: none"> 1. Select automatic correction in menu. 2. Adjust clock and phase position in menu.
Image lack of color, color is incorrect	<ol style="list-style-type: none"> 1. Check whether VGA is not well connected or has quality problem. 2. Adjust chromaticity and brightness or contrast in menu.
Display format that is not supported	<ol style="list-style-type: none"> 1. Select automatic correction in menu. 2. Adjust clock and phase position in menu.

Touch Function

Touch function invalid	<ol style="list-style-type: none"> 1. Check whether touch driver is installed and started. 2. Check whether the size of article touched is comparable with finger.
Touch positioning not correct	<ol style="list-style-type: none"> 1. Check whether driver is properly installed and make correction. 2. Check whether touch pen is facing the screen.

Video function can't work normally

No picture and no sound	<ol style="list-style-type: none"> 1. Check whether the machine is started state. 2. Check whether signal wire is well plugged, whether INPUT is corresponding to it. 3. If in internal computer mode, check whether internal computer is started.
With horizontal or vertical stripes or image dithering	<ol style="list-style-type: none"> 1. Check whether signal wire is well connected. 2. Check whether other electronic equipment or power tools are placed around the machine.
No color, color is weak or image is weak	<ol style="list-style-type: none"> 1. Adjust chromaticity and brightness or contrast in menu. 2. Check whether signal wire is well connected.

Audio function can't work normally

With image but without sound	<ol style="list-style-type: none"> 1. Check whether mute button is pressed for mute. 2. Press VOL. + / - to adjust volume. 3. Check whether audio line is connected correctly.
Only one speaker has sound	<ol style="list-style-type: none"> 1. Adjust sound balance in menu. 2. Check whether computer sound control panel only sets up one sound channel. 3. Check whether audio line is connected correctly.
VGA output without sound	<ol style="list-style-type: none"> 1. Check whether connect external device with headphone cable.

Maintenance

Proper maintenance can avoid many early faults and regular careful cleaning can make machine brand new. Please unplug power plug before cleaning and maintenance, to prevent electric shock.

Clean screen

Please mix and stir even a little fabric softener or tableware detergent with warm water.

Please use a soft cloth to be completely soaked in the mixture.

Please take out cloth and twist to half dry state to wipe machine screen.

Repeat for several times, pay attention not to squeeze water flow into machine when wiping machine.

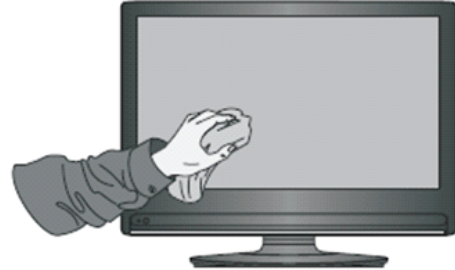

Clean face frame

Please use dry, soft, lint-free cloth to wipe front frame.

No use of machine for a long time

In case of no use of machine for a long time, such as holiday, please make sure to unplug the plug to prevent any possible dangers caused by power supply ripple from lightning.